

Vickers®

Directional Controls

www.kianhydraulic.com



CETOP 3 Size Soft Shift

Directional Control Valves

DG4V-3(S)-60 Design



VICKERS

Revised 6/93

Table of Contents

DG4V-3(S) Model Code	4
DG4V-3(S) Operating Data	5
Basic Characteristics	
Mounting Interface	
Functional Symbols	
Seals & Fluid Cleanliness	
Solenoid Energizing	6
Bleeding Procedure	
Specifications	
Valve Port Restrictor Plugs	
Response Time	7
Orifice Changing Procedure	
Performance Data	8
Pressure Drops	
Maximum Flow Data	9
Installation Dimensions	10
Electrical Connectors	12
Mounting Interface	13

Introduction

General Description

Basically, these solenoid operated directional control valves are for directing and stopping flow at any point in a hydraulic system.

The soft shift feature is designed to provide smoother control of actuator acceleration and deceleration than is possible with conventional solenoid valves. The result is minimum hydraulic shock, more reliable systems with longer component life and less downtime.

Features & Benefits

- Milled metering notches on the spool enable precise control of flow rate change as the spool is shifted.
- Easily interchangeable orifice plugs allow for fine tuning of valve shift time to each application.
- Standard and high performance solenoids offer designers a choice of flow and tank pressure ratings to match system requirements.
- A "P12L" model offers a junction box with rectifier, lights and plug-in coils for quick and easy solenoid changing without removing the valve from the machine.
- Installed cost and space savings from higher power/weight—and—size ratios.
- Reduced internal leakage reduces power losses, increases system efficiency: the result of improved manufacture of spool and bores.
- Installation flexibility resulting from a choice of numerous combinations of solenoid connectors and locations.
- Multi—fluid capability without need to change seals.
- Higher sustained machine productivity and higher uptime because of proven fatigue life and endurance, tested over 20 million cycles.
- Solenoid coils can be changed quickly and easily without leakage from hydraulic system.
- Compact, cost effective system design when used with Vickers SystemStak™ valves and multi—port subplates.

DG4V-3(S) Soft Shift Model Series

Model Code

DG4V - 3(S) - ** (L) 2 ** - (P2) - (V) M - * * * * (L) - * * H * - 60 - (P*-A*-B*-T)

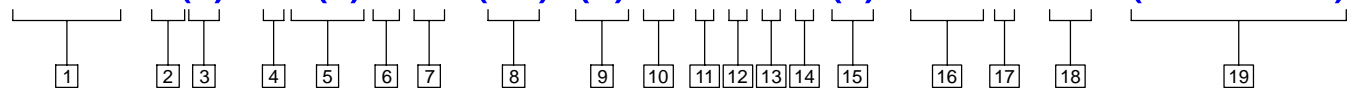

1 Valve Type

D – Directional control valve
G – Subplate mounted
4 – Solenoid operated
V – Rated pressure (350 bar)

2 Interface

3 – ISO 4401-03, CETOP 3 (NFPA D03)

3 Valve Performance

S - Standard performance
Blank - High performance

4 Spool Types

0 – Open center
2 – Closed center (all ports)
3 – P & B closed, A to T
6 – Closed center (P only)
8 – Tandem center (open crossover)
31 – P & A closed, B to T
33 – Closed center (bleed A & B)

5 Spool/Spring Arrangement

A – Spring offset, single solenoid
AL – Spring offset, single solenoid (left hand build)
B – Spring centered, single solenoid
BL – Spring centered, single solenoid (left hand build)
C – Spring centered

6 Soft Shift Valve

7 Soft Shift Orifice Size

00 – No orifice
07 – 0.7 mm dia.
08 – 0.8 mm dia.
09 – 0.9 mm dia.
20 – 2.0 mm dia*

* Minimum orifice size recommended for high performance type "8C" spool.

8 Manual Override

Blank – Override in solenoid end only
P2 – Manual override in end cap and solenoid, A & B models only.

9 Solenoid Energization identity

Blank – ANSI B93 energize solenoid A to give flow P to A
V – Solenoid identification determined by position of solenoid (i.e. solenoid A is at port A end of valve, solenoid B is at port B end of valve.)

10 Flag Symbol

(Introduces electrical features and options)

11 Coil Types

F – Flying lead type coils
U – DIN 43650 coils
SP1 – Single 1/4" male spade
SP2 – Dual 1/4" male spade
P12L – Plug-in coils w/rectifier in junction box, lights included.
KU – Top exit flying leads

12 Coil Connectors

("U" type coils only, omit if not required)
1 – Connector fitted
6 – Connector with light fitted
11 – Rectifier with lights fitted
12 – Rectifier fitted

13 Electrical Connections

("F" type coils only, omit if not required)
PA – Insta-plug male recpt. only
PA3 – 3-pin receptacle
PA5 – 5-pin receptacle
PB – Insta-plug male & female recpt.
T – Terminal block

14 Wiring Housing Thread

("F" type coils only, omit if not required)
W – 1/2" NPT
J – M20 x 1.5 - 6H
G – G1/2

15 Solenoid Indicator Lights

(Not available on PA, U, SP1, SP2. Omit if not required.)

16 Coil Identification Letter

GH – 12V DC
DTH – 18V DC
HH – 24V DC
DJH – 98V DC (req'd. for P12L models)
PH – 110V DC
SH – 220V DC

17 Tank Pressure Rating

2 – 10 bar (145 psi)
5 – 100 bar (1450 psi) for DG4V-3S
7 – 207 bar (3000 psi) for DG4V-3

18 Design Number

19 Port Orifices

Blank – 00
03 - 0.3 mm dia.
06 - 0.6 mm dia.
08 - 0.8 mm dia.
10 - 1.0 mm dia.
13 - 1.3 mm dia.
15 - 1.5 mm dia.
20 - 2.0 mm dia.
23 - 2.3 mm dia.
(Example: "P03" = 0.3 mm dia. orifice in P port of valve. Omit if not required.)

DG4V-3S-60 Operating Data

Basic Characteristics

Max. pressure ports P, A & B:
 350 bar (5075 psi)
 Max. pressure port T:
 3S 100 bar (1450 psi)
 3 207 bar (3000 psi)

Max. flow: 3S .. up to 40 l/min
 (10.5 USgpm)
 3 ... up to 76 l/min
 . (20 USgpm)

Mounting Interface

ISO 4401-03
 CETOP 3
 NFPA D03

Seals & Fluid Cleanliness

Fluorocarbon seals are standard and are suitable for use with phosphate ester type fluids or its blends, water glycol, water-in-oil emulsion fluids and petroleum oil.

Proper fluid condition is essential for long and satisfactory life of hydraulic components and systems. Hydraulic fluid must have the correct balance of cleanliness, materials and additives for protection against wear of components, elevated viscosity and inclusion of air.

Essential information on the correct methods for treating hydraulic fluid is included in Vickers publication 561; "Vickers Guide to Systemic Contamination control," available from your local Vickers distributor or by contacting Vickers, Incorporated.

Recommendation of filtration and the selection of products to control fluid condition are included in 561.

Recommended cleanliness levels using petroleum oil under common conditions

is based on the highest fluid pressure levels in the system.

Directional controls, regardless of manufacturer, will operate with fluids showing a higher cleanliness code. The operating life of the control, and other components in the system, will be less however. For maximum life and best system performance, cleanliness codes as defined below should be achieved.

Fluids other than petroleum, severe service cycles or temperature extremes are cause for adjustment of these cleanliness codes. See Vickers Publication 561 for exact details.

Valves	System Pressure		
	1000 psi	2000 psi	3000+ psi
DG4V-3S-60	20/18/15	20/18/15	19/17/14

Functional Symbols

Standard Spool Types	Graphic Symbol Center Condition	Spring Offset	Spring Centered
0			
3			
2			
6			
8			
31			
33			

DG4V-3S-60 Operating Data

Solenoid Energizing

Spring centered and spring offset valves will be spring positioned unless the solenoid is energized continuously.

NOTE

Any sliding spool valve, if held shifted under pressure for long periods, may stick and not spring return, due to silting. Therefore, it is recommended that the valve be cycled periodically to prevent this from occurring.

Only DC coil voltages are available. For applications where the junction box is required, valves with F (flying lead) type coils must be driven by a DC electrical signal. The P12L models must be driven by a 110-120, 50-60 Hz AC signal. For other applications, rectified DIN connectors ('11' or '12' in model code) can be used to convert AC input voltage to the DC voltage necessary to power the valve.

NOTE

The P12L designated coil is rectified.

Bleeding Procedure

Apply a minimum of 3.4 bar (50 psi) tank pressure. Shift either solenoid "a" or "b". Loosen manual actuators in solenoid ends until air is evacuated. Retighten manual actuators. No further bleeding should be required.

Initial start ups thereafter will require 6-8 shifts to refill solenoid tubes. Addition of a back pressure check valve may be required to prevent bleed down.

Drain

The tank line must be plumbed above the level of the core tube (and valve body). This will insure that the tank port

is always flooded with oil. By doing this, the core tube will remain flooded with oil and the soft shift operate as designed.

Specifications

Maximum flow See curves
 Maximum operating pressure 350 bar (5000 psi)
 Rated fatigue pressure ports A, B and P 350 bar (5000 psi)
 Maximum tank line pressure 3S 100 bar (1450 psi)
 3 207 bar (3000 psi)
 Mounting interface ISO 4401-3, CETOP 3

Weights

Double solenoid models 2.1 kg (4.6 lbs)
 Single solenoid models 1.7 kg (3.7 lbs)

Solenoids

Solenoid Voltage DC	Solenoid ID	Amps	Watts	Ohms
12	GH	3.1	39	3.8
24	HH	1.5	36	15.9
98	DJH	.38	35	275
110	PH	.34	37	328
18	DTH	2.1	39	8.4
220	SH	.17	37	1280

Valve Port Restrictor Plugs

Restrictor plugs are available for use in ports P, T, A, or B. These can be used for restricting flow or for circuit dampening. Restrictor plugs are not recommended for use above 210 bar (3000 psi) system pressure.

694347	2,00 (0.080)	*20
694348	2,30 (0.090)	*23

† – Available in multiples of 25 per part number

* – P, T, A, or B as required

Part Number†	Orifice Ø	Model Code
694353	Blank	*00
694341	0,30 (0.012)	*03
694342	0,60 (0.024)	*06
694343	0,80 (0.030)	*08
694344	1,00 (0.040)	*10
694345	1,30 (0.050)	*13
694346	1,50 (0.060)	*15

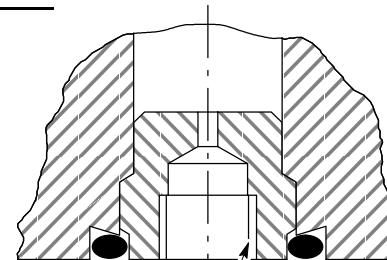

M5 x 0.8-6H thread for plug extraction

DG4V-3S-60 Operating Data

Response Time

Response times are increased over that of a standard solenoid. These times are influenced by flow, pressure, applied solenoid voltage, oil viscosity and ambient temperatures.

Response times can be fine tuned to the application by orifices that are interchangeable via the manual actuator in the solenoid end. See model code for available orifices.

Response times shown are for a type "2C" spool at a system pressure of 207 bar (3000 psi), flow at 19 L/min (5 USgpm), solenoid voltage at 100% of rating and 38° C (100° F) oil

temperature. Times are determined from the instant of power on/off to the point of maximum cylinder velocity (shift) or the end of cylinder movement (spring return). All times are without arc suppression diodes. Spring return times can be expected to increase with diodes in place.

Response times greater than 700 msec are not recommended.

NOTE

For the high performance type "8C" model, core tube orifice sizes smaller than 2.0 mm diameter are not recommended.

Orifice Diameter mm	Response Times		Color Code
	Shift (ms)	Spring Return (ms)	
0,7	625	550	Green
0,8	400	375	Blue
0,9	250	250	Purple

Response times for spools other than the 2C spool are similar and are system dependent.

Orifice Changing Procedure

WARNING

1. Before breaking a circuit connection make certain that power is off and system pressure has been released. Lower all vertical cylinders, discharge accumulators and block any load whose movement could generate pressure. Plug all removed units and cap all lines to prevent entry of dirt into the system.

2. Using a $\frac{5}{32}$ " hex key, remove manual actuator plug and spring from the end of solenoid (Tightening torque 6.2–7.3 N.m 55–65 lbf.in.)
3. Insert extraction tool (878495) into solenoid via the manual actuator opening. Rotate tool until aligned and push pin into slot in armature.
4. Using $\frac{1}{2}$ " wrench and tool to prevent the armature from rotating, insert $\frac{3}{32}$ " hex key down the center of tool and remove orifice plug.

5. Replace by the same method, tightening orifice snug to ensure bottoming of threads. Smaller orifices increase response times, larger orifices decrease response time.

Orifice & Tool Kit 02-140211

For fine tuning shift performance, orifices must be ordered separately. The kit includes (2) each of .7, .8 & .9 mm dia. orifices, (1) installation tool, (1) $\frac{5}{32}$ " hex key and (1) $\frac{3}{32}$ " hex key.

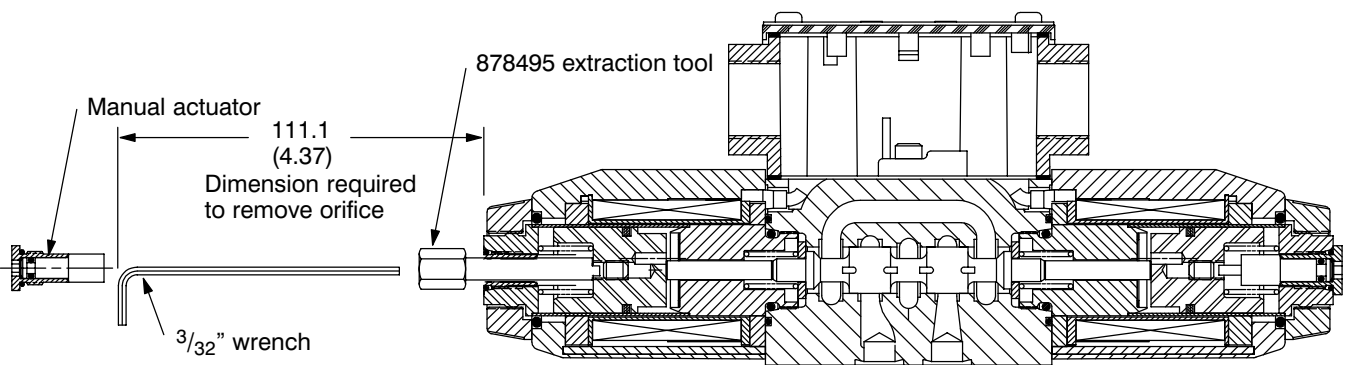

Performance Data







Pressure Drops

The pressure drop values shown are typical. Actual pressure drops will vary $\pm 10\%$.

The pressure drop curves give approximate pressure drop (ΔP) when passing 21 cSt (100 SUS) fluid having .865 specific gravity through the indicated flow path.

For any other viscosity, the pressure drop (ΔP) will change as follows:

Viscosity(s cSt (SUS))	14 (75)	32 (150)	43 (200)	54 (250)	65 (300)	76 (350)	87 (400)
% of ΔP (Approximate)	93	111	119	126	132	137	141

Spool Type	Pressure Drop Curve Reference Chart			
	P-A	B-T	P-B	A-T
Spring Centered				
 "0C" +	5	1	5	1
 "2C"	5	4	5	4
 "6C"	6	1	6	1
 "8C" +	5	3	5	3
 "3C"	5	4	5	1
 "31C" *	5	1	5	4
 "33C" *	6	2	6	3

Spring Offset	P-A	B-T	P-B	A-T
 "2A"	7	5	8	5

* NOTE: Type "33" spool at center will pass 650 ml/min (40 in³/min) to 15 L/min (4.0 USgpm) at 103 bar (1500 psi) tank pressure to both "A" and "B" ports.
 "+" type "0C" and "8C" centered pressure drop P to T represented by curve number "5". Cylinder ports blocked for type "0C".

Pressure Drop Curves

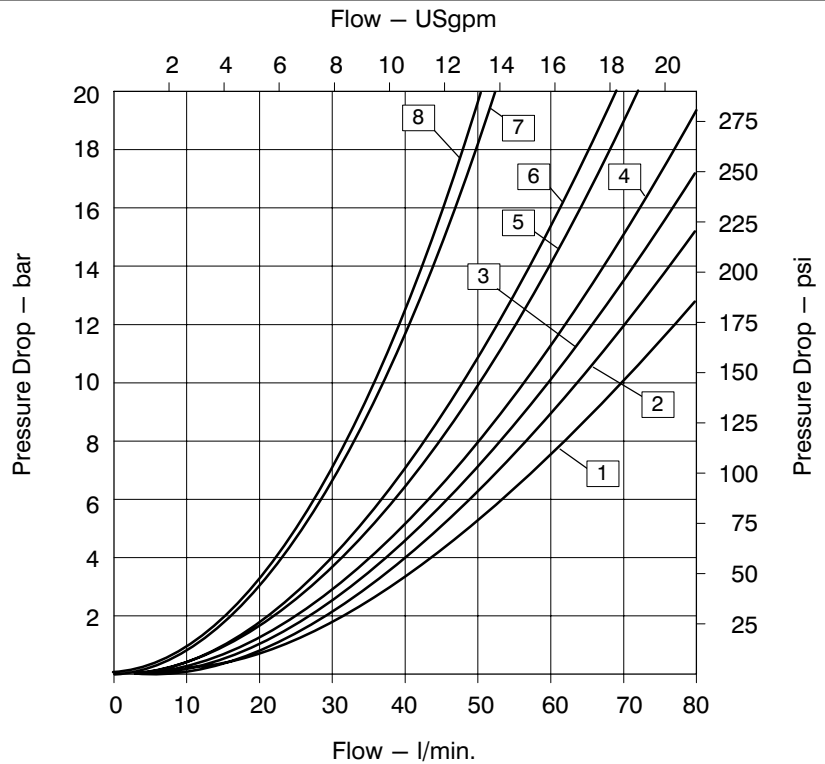

Performance Data





Maximum Flow Data

Maximum recommended flow data is for 90% nominal voltage in a 4-way circuit with cylinder ports either looped or blocked and containing 2,5 liters (.66 USgal) compressed volume. Reduced performance may result when certain spools are used in 3-way circuits.

Flow rates are based on warm solenoids operating at minimum rated voltage (i.e. 90% of rating), standard 0.8 mm orifice and 38C° (100° F) oil temperature.

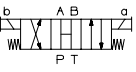
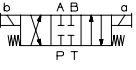
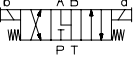
NOTE

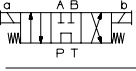
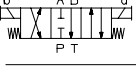
2.0 mm diameter orifice for the high performance type "8C".

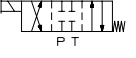
Spool Type	Curve Number	
	"3S"	"3"
 0C	6	10
 2C	1	10
 6C	2	8
 3C	2	9
 8C	5	7
 31C	2	9
 33C	3	9
 2A	4	8

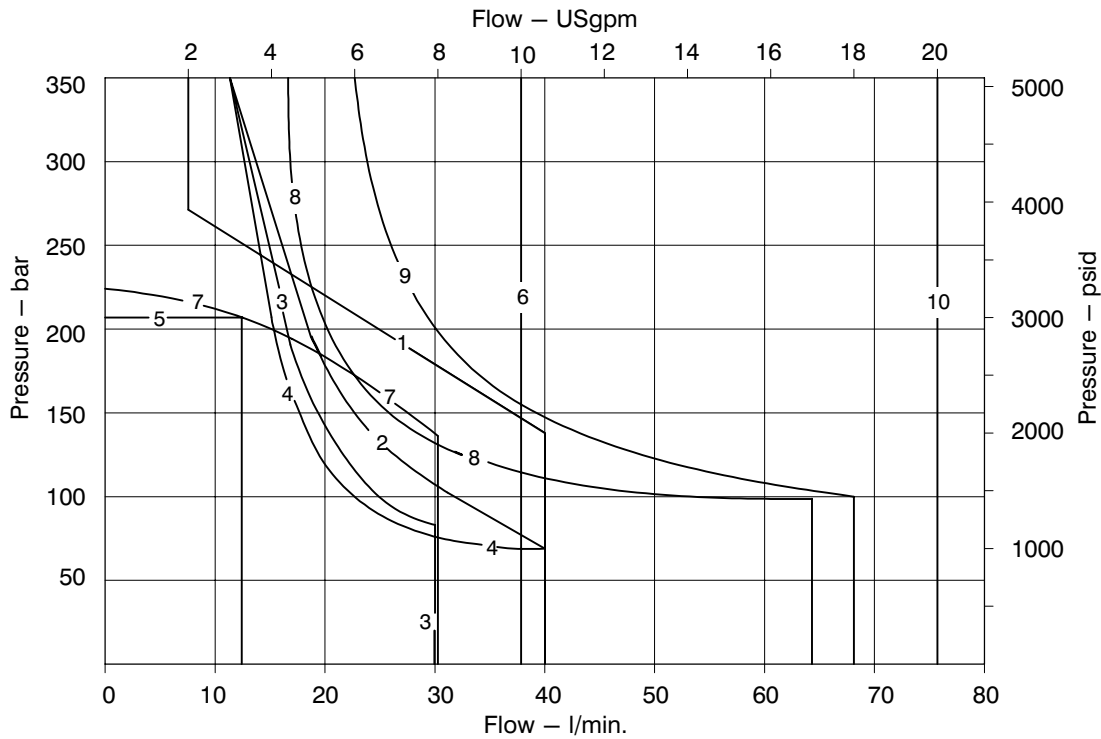

Installation Dimensions

DG4V-3(S)-**2**-(V) M-F**** (L)-*H5-60

Flying Lead Model

Millimeters (inches)

Flying lead models
(All options except "PB")

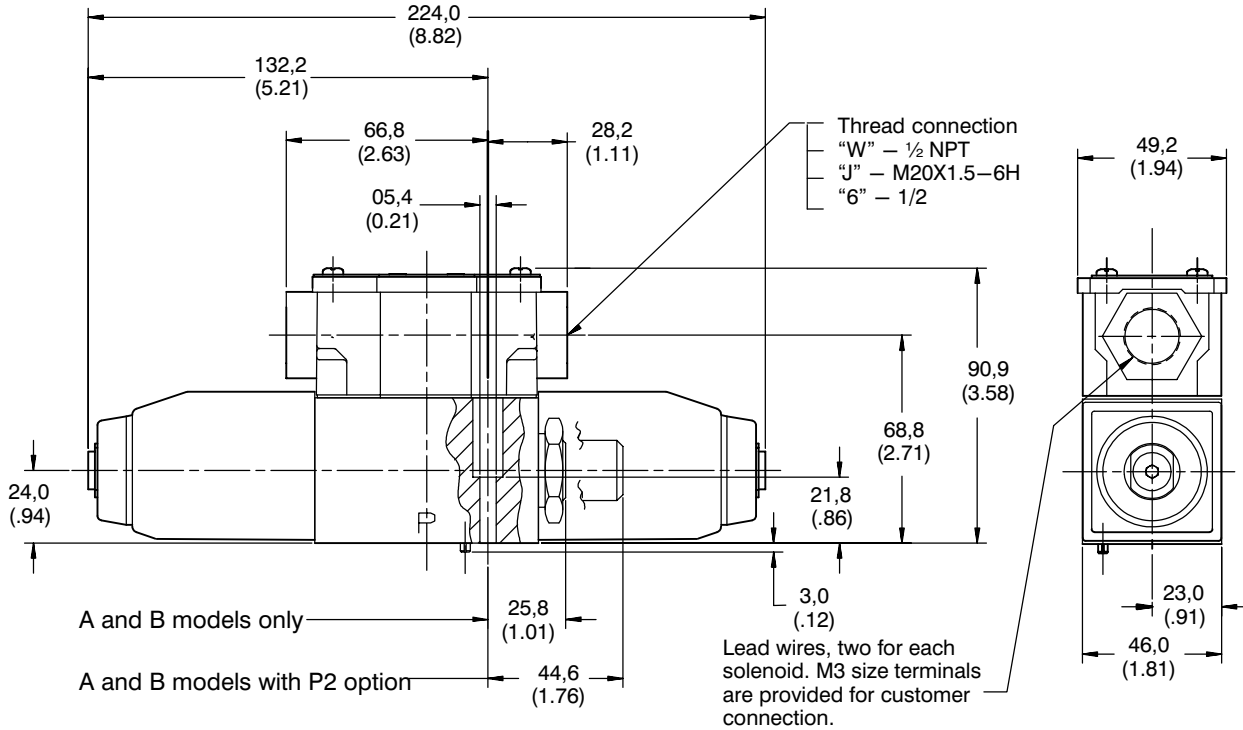

DG4V-3(S)-**2**-(V) M-U/SP1/SP2-*H5-60

DIN Connector

Millimeters (inches)

Coil Connector (installed at factory)
 "1" – Standard connector
 "6" – Standard connector with lights
 "11" – Rectified connector with lights
 "12" – Rectified connector

Coil Types
U – DIN 43650 coils (shown)
 (DC voltages only)
SP1 – Single 1/4" male spade
 (SAE JB5BA Type 1A)
 (DC voltages)
SP2 – Dual 1/4" male spades
 (SAE JB5BA Type 1A)
 (DC voltages)

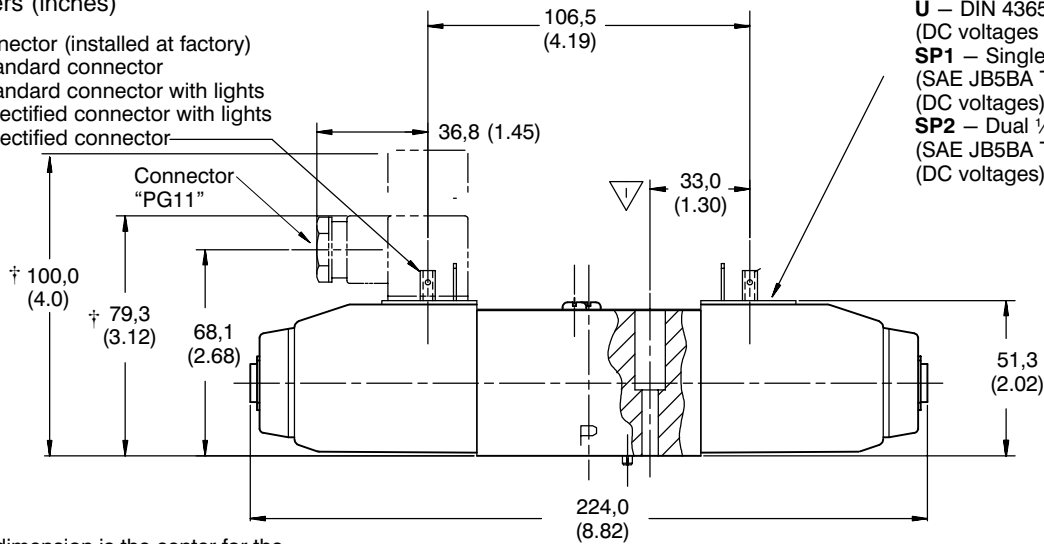

▽ This dimension is the center for the female connector and applies to "U", "SP1" and "SP2" coil type units.

† This dimension can vary depending on source of plug.

Installation Dimensions

DG4V-3(S) - **2**-M-P12L-DJH5-60 Plug-in Coil

Millimeters (inches)

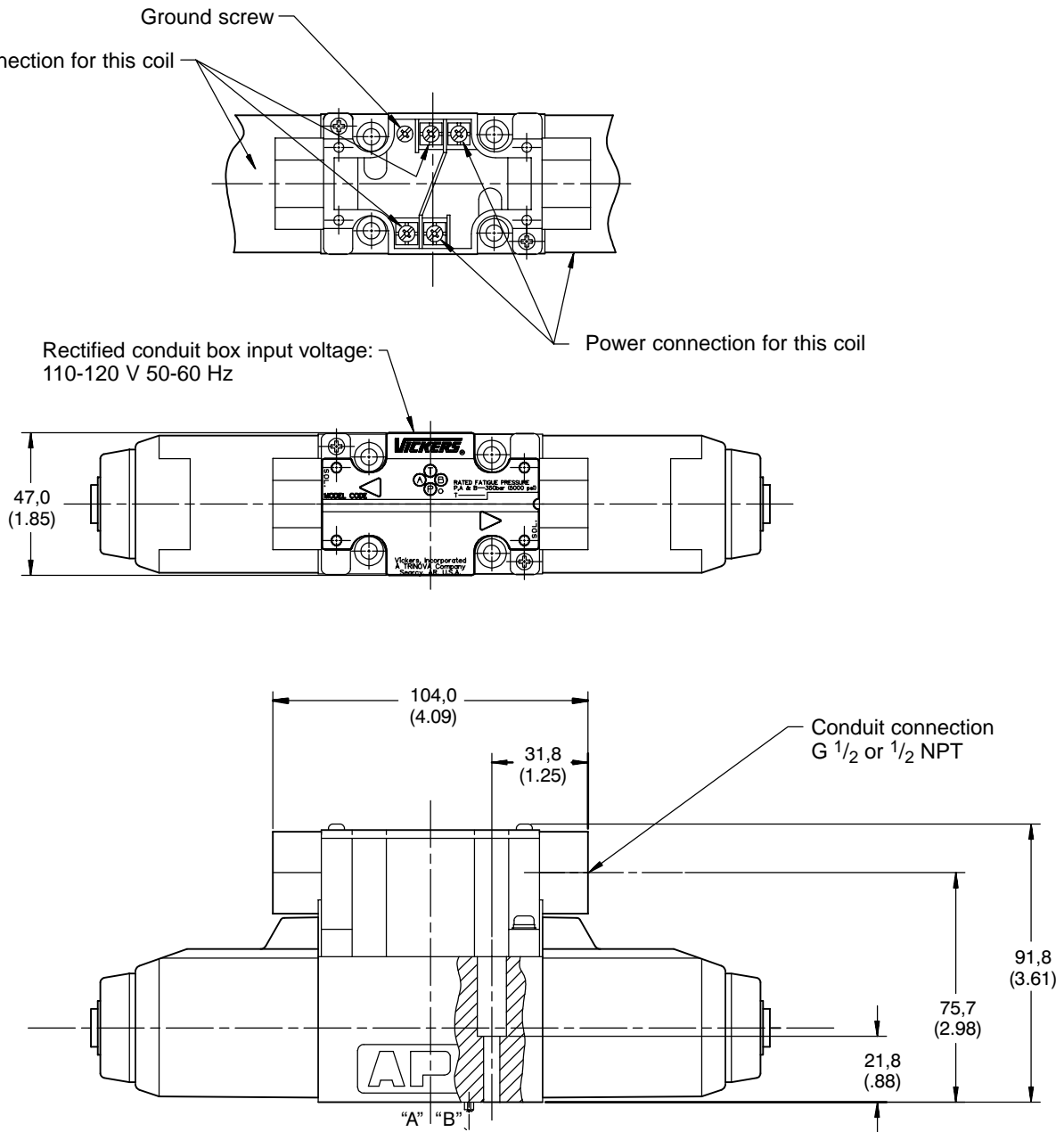

Electrical Connectors

DG4V-3(S)-**2**-M-FPB Insta-plug Option

Millimeters (inches)

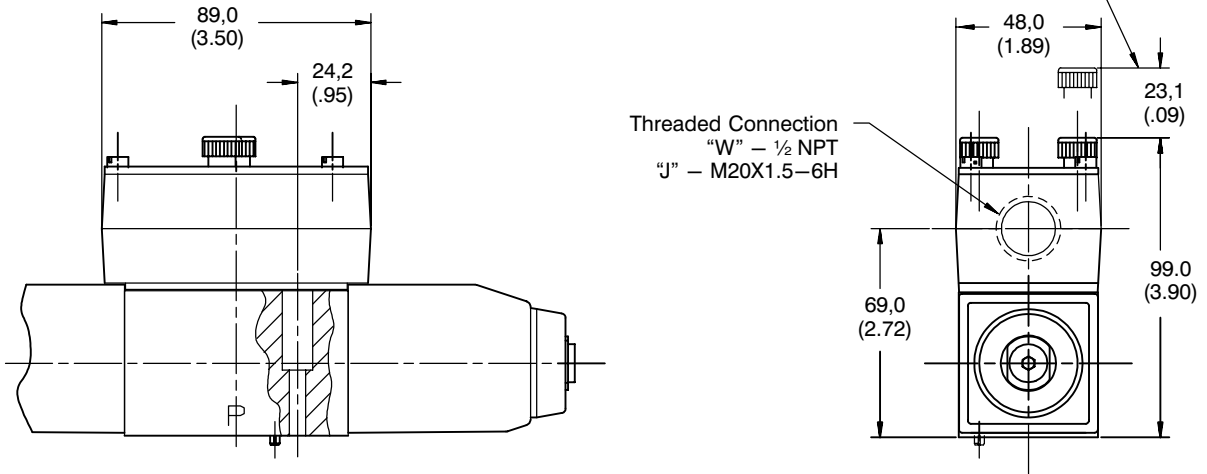

NFPA Electrical Connector

The receptacle is a standard three or five pole electrical connector with shortened leads and terminals added. The connector is assembled over the solenoid "B" on dual solenoid models and over the solenoid "A" for single solenoid models.

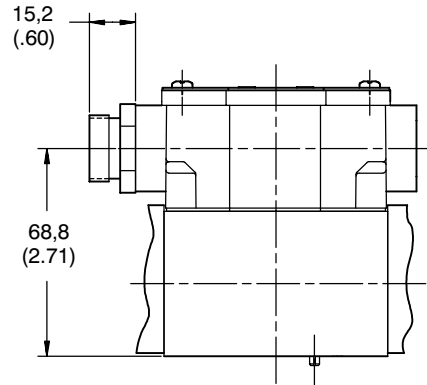

MODEL:
DG4V-3(S)-*A/B2**-M-FPA3

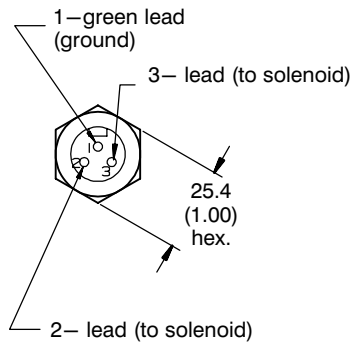

MODEL:
DG4V-3(S)-*A/B2**-M-FPA5

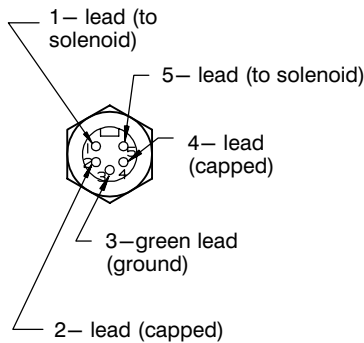

MODEL:
DG4V-3(S)-*C2**-M-FPA5

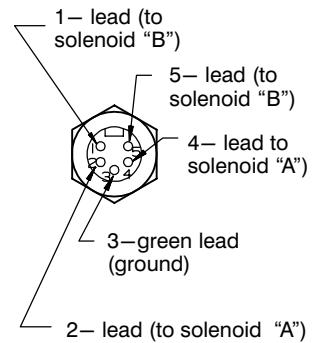

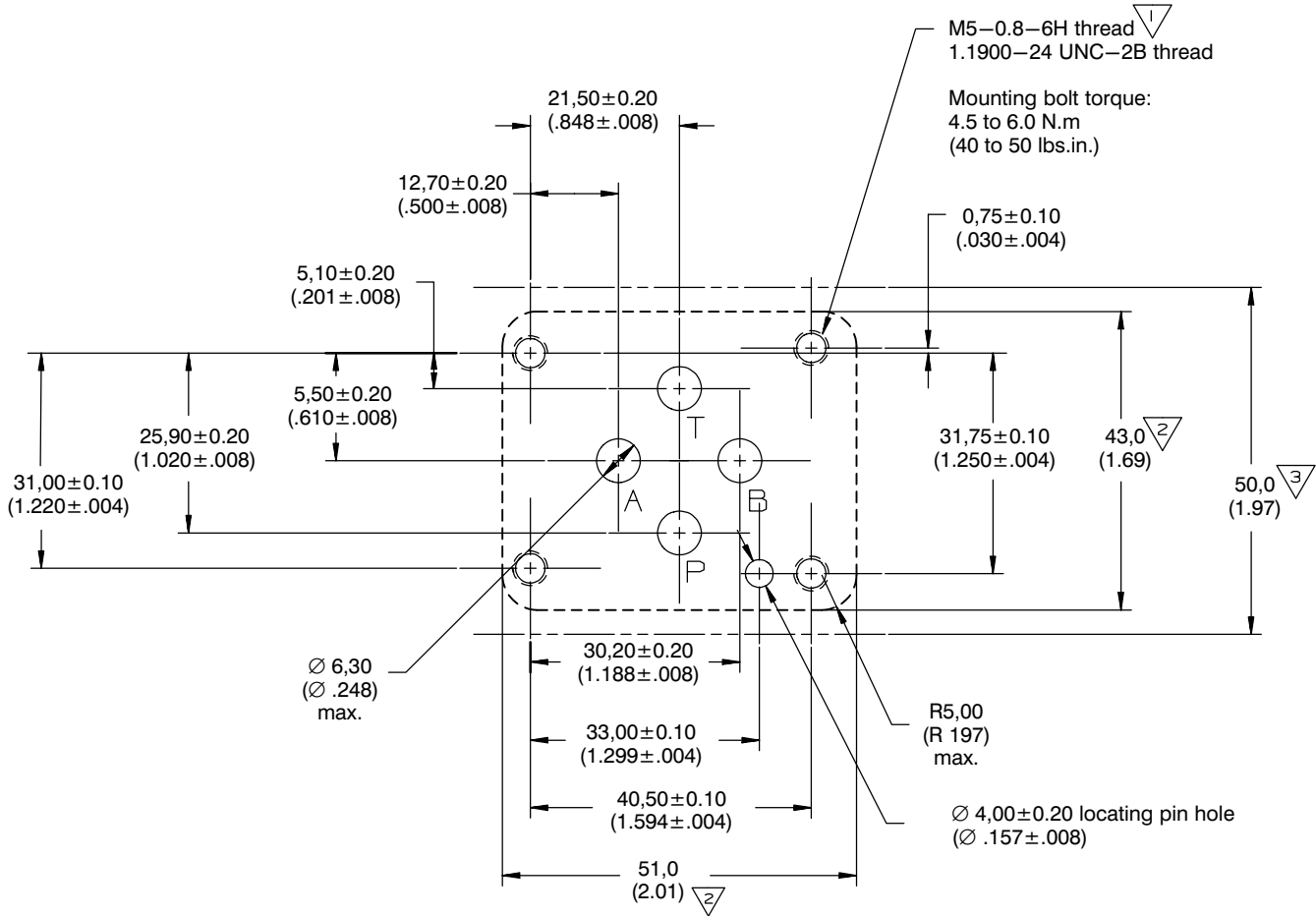

1 The minimum thread depth is 1.5 of bolt diameter. The recommended full thread depth is $2xD+6\text{mm}$ to aid in the interchangeability of valves and to reduce the number of fixing bolt lengths. The recommended engagement of fixing bolt thread for ferrous mountings is $1.25 D$.

2 The dimensions specifying the area within the dotted lines are the minimum dimensions for the mounting surface. The corners of the rectangle may be radiused as shown.

3 This dimension gives the minimum spacing distance between the valves and adjacent obstructions. For example, another valve or a wall. This dimension is therefore, the minimum distance from centerline to centerline of two similar mounting surfaces placed on a manifold block. The fixing holes are at equal distances to this dimension.

The mounting surface must be flat within 0.013 mm (.0005 inch) and smooth within 1.1 micrometer (0.045 microinch). Mounting bolts should be grade 12.9 (SAE grade 7) or better.

Subplate & Bolt Kits

Valve subplates and mounting bolts must be ordered separately.

Example:

- (1) DG4V-3S-2C208-M-FW-6H5-60 valve
- (1) DGVM-3-10-S subplate
- (1) BK590716 inch mounting bolt
- (1) BK616452M metric mounting bolt kit